

TireScan™ System

Tire Footprint Pressure Mapping System

The TireScan™ System is a unique tool used to capture static or dynamic tire footprint patterns using a tactile pressure sensor. The system's tailored graphing and image analysis software enable quantitative and qualitative evaluation of tire behavior.

Capture static or dynamic tire footprint pressure patterns for tread analysis

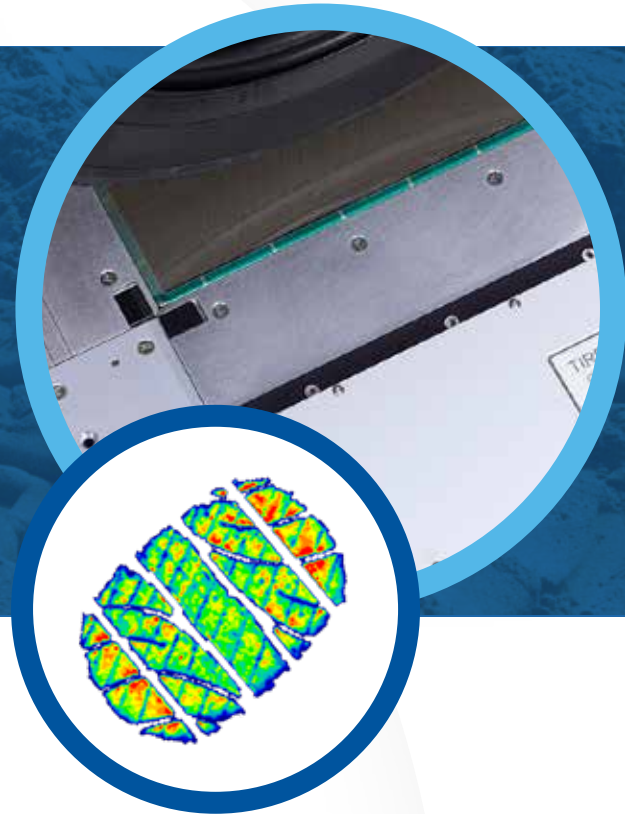

TIRESAN SYSTEM CONFIGURATIONS

- CrossDrive Systems
- VersaTek™ Systems
 - Passenger, Bus & Small Truck
- VersaTek™ Systems
 - Aircraft, Agricultural, Truck & Bus

KEY FEATURES (BENEFITS)

- Dynamic recording and playback
- Graphing and data analysis capabilities
- Quickly generate custom reports
- Durable & reusable sensors
- Thin & incompressible - dimensional stability is key for repeatable measurements
- Fast testing procedure. No ink, paper, or scanning

APPLICATIONS

- Tire footprint pressure pattern evaluation
- Tread design
- Manufacturing quality assurance
- Vehicle suspension analysis

TIRE TYPES

- Passenger
- Bus
- Truck
- Agricultural
- Aircraft
- Racing
- ATV
- Motorcycle

General Sensor Specifications

Sensor Technology	Resistive
Accuracy	± 5%
Pressure Range	0-4,100 kPa (0-600 psi)
Thickness	0.2 mm (0.008 in.) Not compressible

SYSTEM HARDWARE OPTIONS

CrossDrive System: Base plate with fully integrated electronics that connect to sensor with a large sensing area and high resolution. Supports a wide range of tire measurements with a single configuration.



VersaTek System: Modular hub and ruggedized handles that can connect with a variety of sensors. Handles can be mounted to base plates for improved electrical and mechanical grounding.



System Models

Tire Types to be Measured	CrossDrive System	VersaTek System
Passenger, Bus & Small Truck	TCR8540	TVR8404 TVR8406 TVR8408
Agricultural, OTR, Aircraft, Truck & Bus	TCR8540	TVR7202Q TVR7105Q TVR7202 TVR7105 TVR8001

MAP FOOTPRINT IN STATIC OR DYNAMIC APPLICATIONS



Static Load



Dynamic Rolling
(Portable for track testing)

KEY SOFTWARE FEATURES

TireScan provides the tools for more comprehensive and streamlined analysis. The software displays the pressure distribution data in multiple formats.

Real-time display of pressure distribution

Software creates a "Tire Object" that allows the user to fine tune the characteristics of the tire being tested for more precise data. (e.g. area, contact ratio, centerlines, shoulders, rib lines)

The "Tire Object" drives the data that is included in the customized report

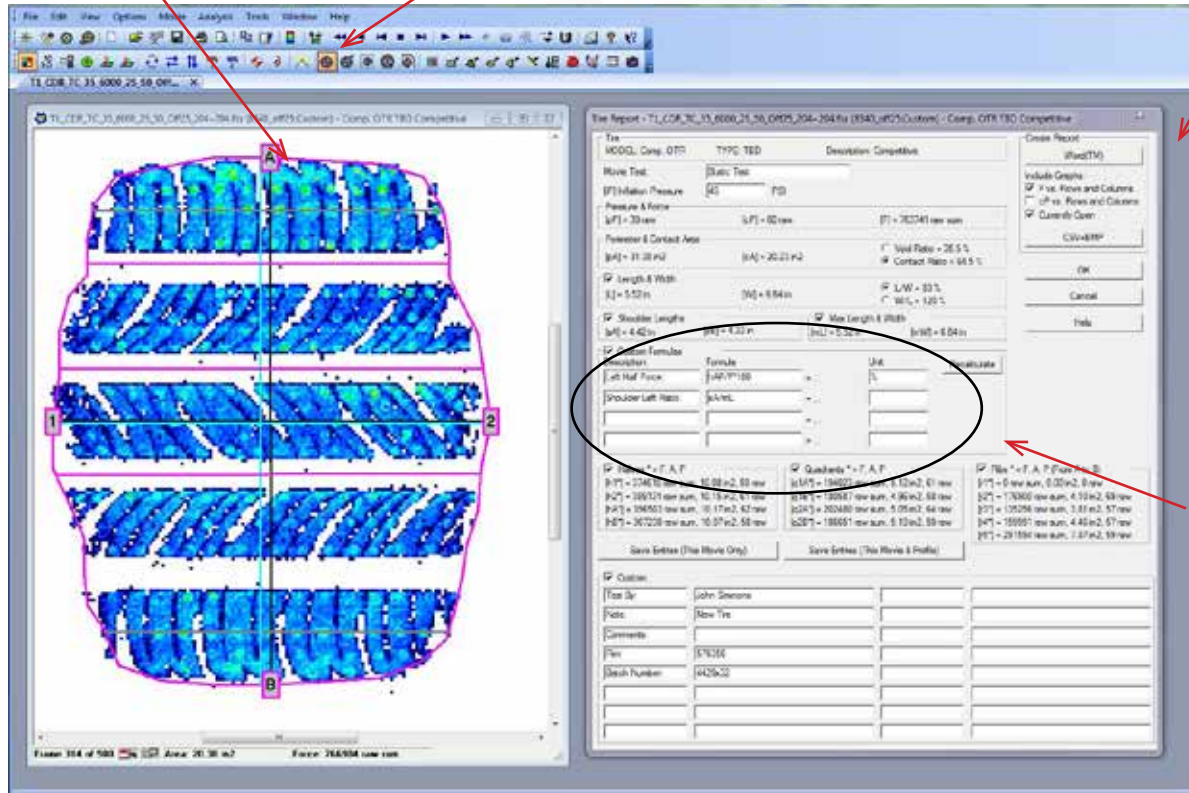

Multiple graph options

Custom formulas can be created that reference the standard values of the tire

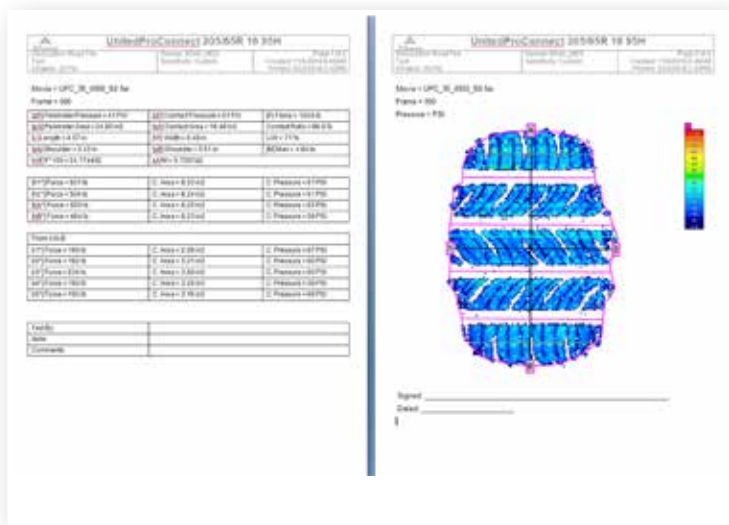

Publish custom reports in Word or CSV format by selecting key metrics for your test

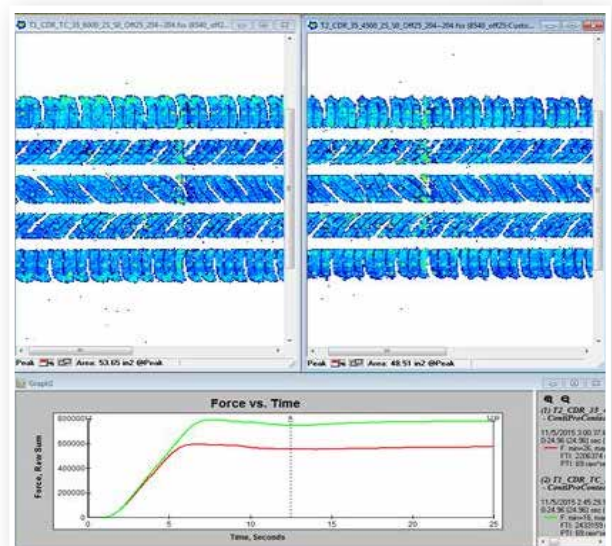

The software can show the highest pressure at each point of the tire's path across the sensor

CROSSDRIVE MULTIPURPOSE TIRE SYSTEM

Tekscan's newest ruggedized TireScan system is capable of measuring large tire footprints at a high resolution. The CrossDrive TireScan system includes integrated data acquisition electronics and sensor designed to withstand harsh testing environments.

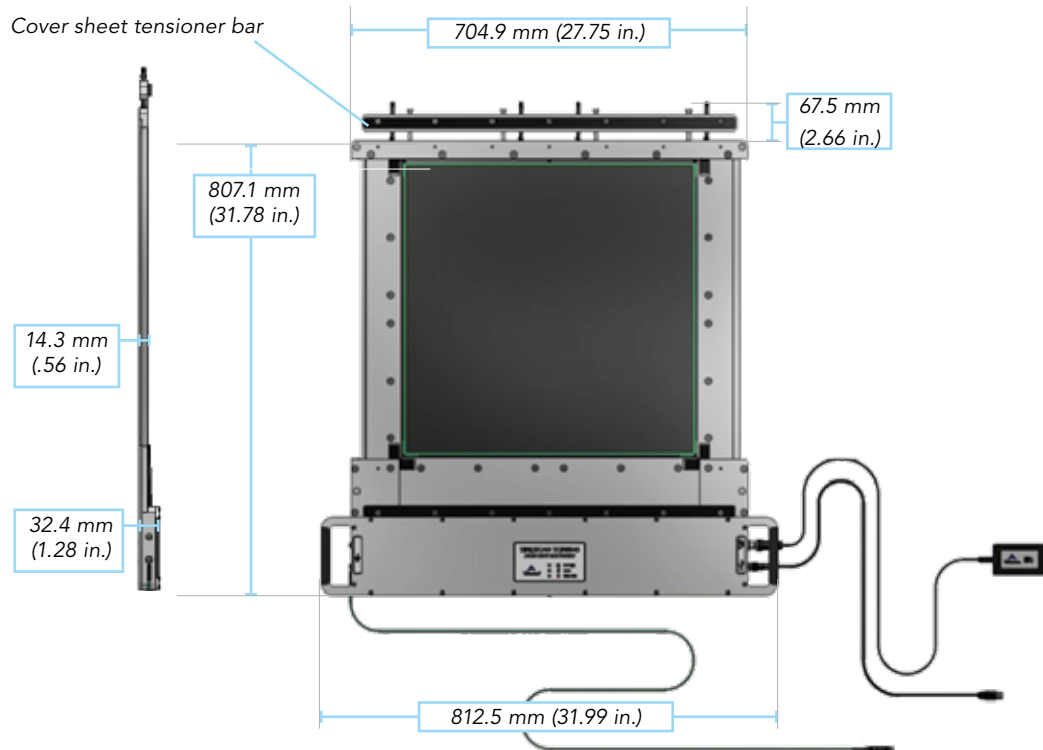
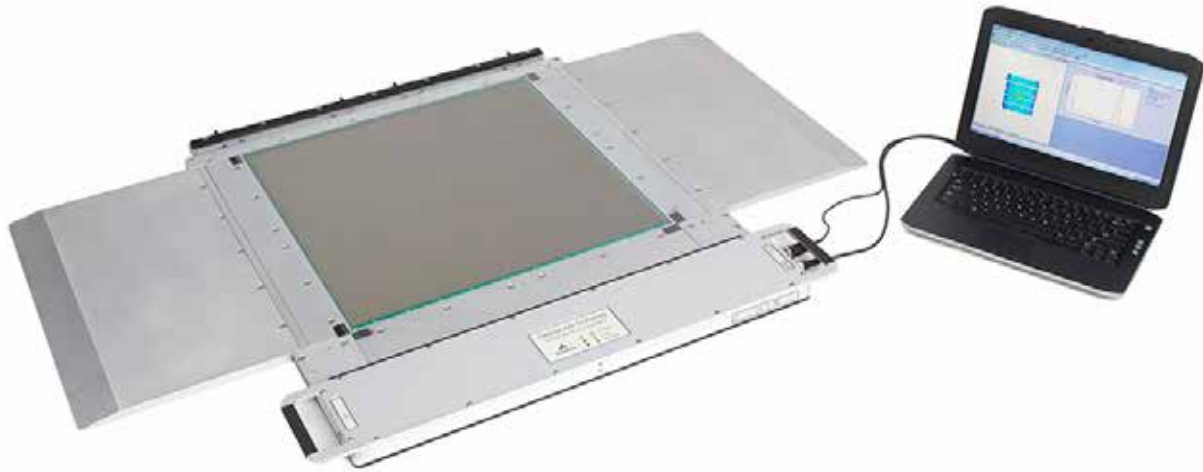

Removable lead and trail plate for use in rolling tests

CROSSDRIVE SENSOR SPECIFICATIONS

System Model

8540

Sensing Area	508 mm x 508 mm (20.0 in. x 20.0 in.)
System Area	704.9 mm x 807.1 mm (27.75 in. x 31.78 in.)
# of Sensing Elements	250,000
Spatial Resolution	1.0 mm x 1.0 mm (0.040 in. x 0.040 in.)
Standard Pressure Range	300 psi
Scanning Rate (Hz)	22

Visual Output

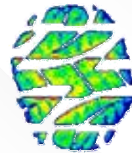

CROSSDRIVE HARDWARE

In order to obtain the pressure data, our scanning electronics scan the thousands of sensing points within each sensor. The data is instantly relayed to the software on your PC via a USB cable.

Ruggedized Housing



Aluminum housing was designed to provide smooth surface for tire to roll over electronics. Leading and trailing plates can be attached for use during rolling tests or removed for static measurements with a load machine.

Shear Force Protection



Sensor is able to withstand aggressive measurements such as Slip Angle testing. (5 kN of shear force shown above)

Data Acquisition Electronics Specifications

Housing Material	Aluminum (Viton seal)
Connection Type	Ruggedized USB 2.0
Weight	72 lbs.
Power Source	Input: 100-240V 5A 50-60 Hz, 1.2A Output: 12V, 5A
Cable Length	3m (10 ft) standard (Up to 5m (16.4 ft) available)
Ambient Temperature	25
Ambient Humidity	

VERSATEK SYSTEM – PASSENGER, BUS & SMALL TRUCK

The Ruggedized TireScan system includes metal scanning electronics enclosures designed to withstand harsh testing environments, a sensor-mounting platform, and leading and trailing drive plates that provide a smooth ride across the sensor.

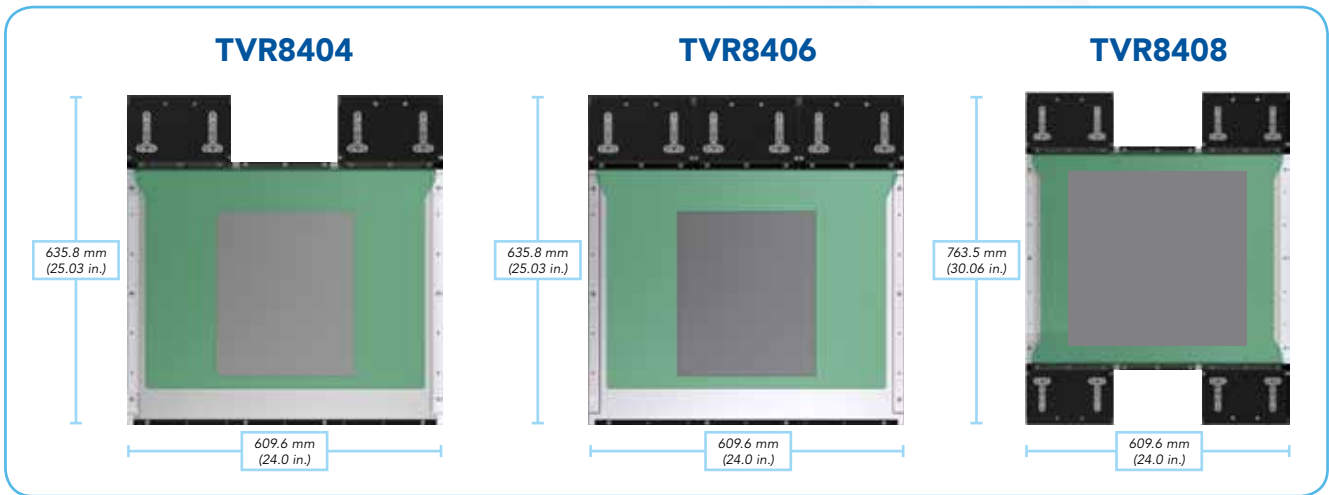

VERSATEK SENSOR SPECIFICATIONS

System Name	TVR8404	TVR8406	TVR8408
Sensing Area	268.2 mm x 317.0 mm (10.56 in. x 12.48 in.)	268.2 mm x 317.0 mm (10.56 in. x 12.48 in.)	402.3 mm x 433.2 mm (15.84 in. x 17.06 in.)
# of Sensing Elements	36,608	82,368	133,408
Spatial Resolution (X,Y)	1.5 mm x 1.5 mm (0.060 in. x 0.060 in.)	1.0 mm x 1.0 mm (0.040 in. x 0.040 in.)	1.1 mm x 1.1 mm (0.045 in. x 0.045 in.)
Standard Pressure Range	300 psi	300 psi	300 psi
Scanning Rate (Hz)	106	71	29
# of Handles	4	6	8
System Weight	35.58 lbs.	39.55 lbs.	43.52 lbs.
Visual Output			

VERSATEK HARDWARE

In order to obtain the pressure data, our scanning electronics scan the thousands of sensing points within each sensor. The data is instantly relayed to the software on your PC via a USB cable.

8-Port VersaTek Hub

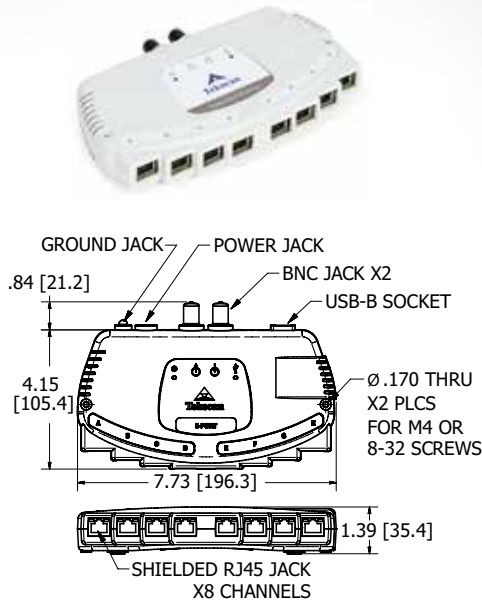

The VersaTek Hub collects data from the VersaTek Handles and sends it over to the PC via USB.

VersaTek Ruggedized Handle (VR2)

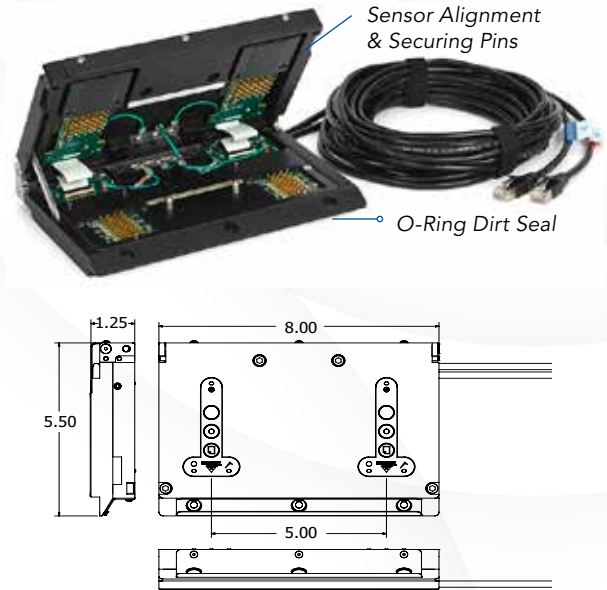

The VersaTek Ruggedized Handle (VR2) connects to the Tekscan sensor tab to scan the sensor as pressure is applied. Housing provides tension to hold sensor flat to the mounting plate and keeps the sensor properly aligned.

VERSATEK SENSOR SPECIFICATIONS

Data Acquisition Electronics Specifications

Housing Material	Handles: Anodized Aluminum (Viton Seal)
	Hub: Polyurethane [PUR] (Grey)
	Base, Lead and Trail Plate: Aluminum
Connection Type	USB 2.0
Power Source	Input: 100-240V 5A 50-60Hz, 1.2A Output: 12V, 5A
Cable Length	Hub to PC: 4.57m (15 ft) standard (Up to 30.48m (100 ft) available)
	Handle to Hub: 3m (10 ft) standard (Up to 5m (16.4 ft) available)
Ambient Temperature	-40° to 60°C (-40° to 140°F)
Ambient Humidity	5% to 90% RH

VERSATEK AIRCRAFT, AGRICULTURAL, TRUCK & BUS

The Ruggedized TireScan system includes metal scanning electronics enclosures designed to withstand harsh testing environments.

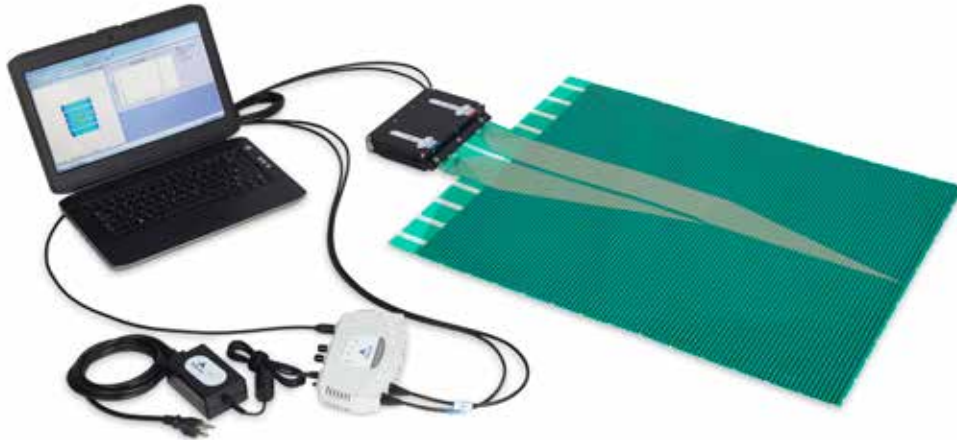

TVR7202Q

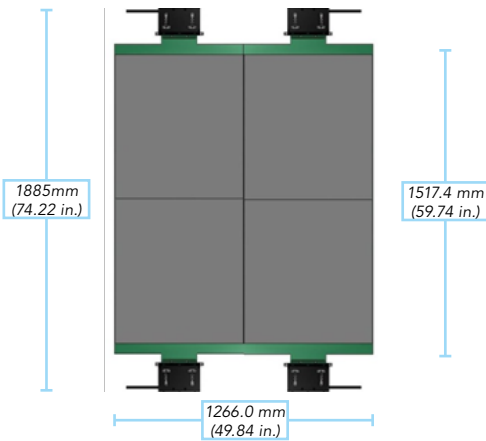

Can be mounted to a 1320.8 x 1905.0 mm (52 x 75 in) base plate.

TVR7105Q

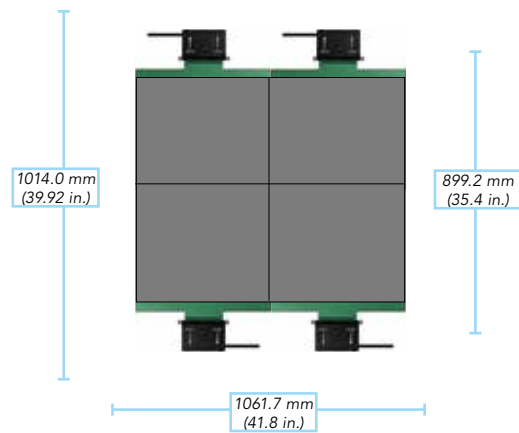

TVR7202

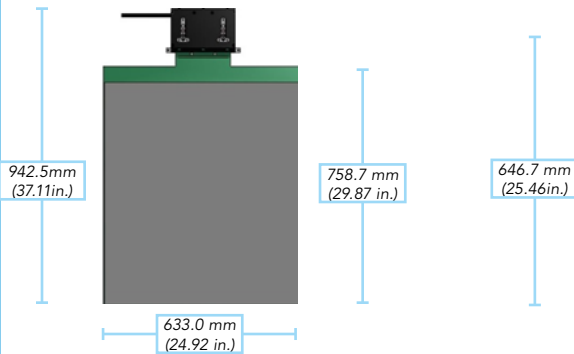

Can be mounted to a 685.8 x 977.9 mm (27 x 38.5 in) base plate.

TVR7105

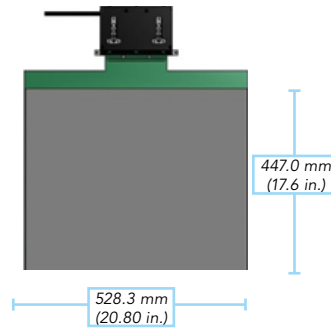

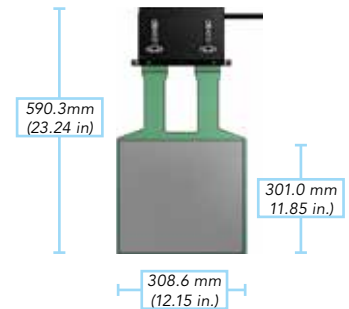

TVR8001

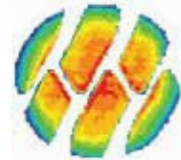

Sensor drawings are not to scale

VERSATEK SENSOR SPECIFICATIONS

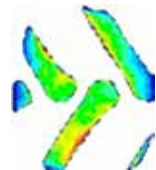
System Name	TVR7202Q	TVR7105Q
Sensing Area	1415 mm x 1259 mm (55.72 in. x 49.56 in.)	899.2 mm x 1061.7 mm (35.40 in. x 41.80 in.)
# of Sensing Elements	34,848	36,996
Spatial Resolution (X,Y)	7.1 mm x 7.1 mm (0.28 in. x 0.28 in.)	5.0 mm x 5.0 mm (0.2 in. x 0.2 in.)
Standard Pressure Range	300 & 600 psi	300 psi
Scanning Rate (Hz)	191	160
# of Handles	8	8
System Weight	20.32 lbs.	20.32 lbs.
Visual Output		

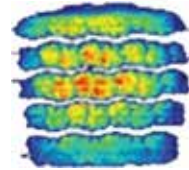
System Name	TVR7202	TVR7105	TVR8001
Sensing Area	704.1 mm x 625.9 mm (27.72 in. x 24.6 in.)	447 mm x 528.3 mm (17.6 in. x 20.8 in.)	292.6 mm x 268.2 mm (11.52 in. x 10.56 in.)
# of Sensing Elements	8,712	9,152	8,448
Spatial Resolution (X,Y)	7.1 mm x 7.1 mm (0.28 in. x 0.28 in.)	5.0 mm x 5.0 mm (0.20 in. x 0.20 in.)	3.0 mm x 3.0 mm (0.120 in. x 0.120 in.)
Standard Pressure Range	300 & 600 psi	300 psi	300 psi
Scanning Rate (Hz)	191	160	173
# of Handles	4	2	2
System Weight	6.91 lbs.	6.91 lbs.	6.66 lbs.
Visual Output			

VERSATEK HARDWARE

In order to obtain the pressure data, our scanning electronics scan the thousands of sensing points within each sensor. The data is instantly relayed to the software on your PC via a USB cable.

8-Port VersaTek Hub

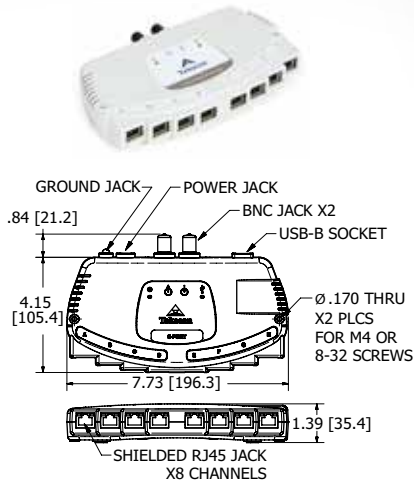

The VersaTek Hub collects data from the VersaTek Handles and sends it over to the PC via USB.

VersaTek Ruggedized Handle (VR2)

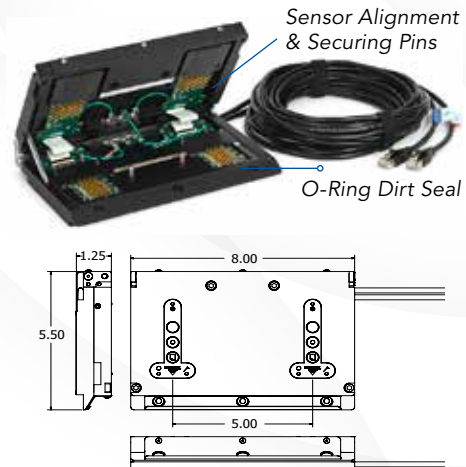

The VersaTek Ruggedized Handle (VR2) connects to the Tekscan sensor tab to scan the sensor as pressure is applied. Housing provides tension to hold sensor flat to the mounting plate and keeps the sensor properly aligned.

Data Acquisition Electronics Specifications

Housing Material	Handles: Anodized Aluminum (Viton Seal)
	Hub: Polyurethane [PUR] (Grey)
	Base, Lead and Trail Plate: Aluminum
Connection Type	USB 2.0
Power Source	Input: 100-240V 5A 50-60Hz, 1.2A Output: 12V, 5A
Cable Length	Hub to PC: 4.57m (15 ft) standard (Up to 30.48m (100 ft) available)
Ambient Temperature	-40° to 60°C (-40° to 140°F)
Ambient Humidity	5% to 90% RH

SENSOR EQUILIBRATION

All TireScan systems include a sensor equilibration device. The equilibration process normalizes all the sensing elements on the sheet, improving the accuracy and extending the lifespan of the sensor.

All TireScan equilibration devices require Pneumatic (compressed air) and can apply a maximum uniform pressure of 100 psi (689 kPa) to a sensor. An equilibrator is included in a system purchase (model dependant on system).



Data Acquisition Electronics Specifications

System Name	PB100H	PB100T	PB100K	PB100F-1	PB100N
TCR8540			X		
TVR8404		X			
TVR8406		X			
TVR8408		X			
TVR8001	X			*	*
TVR7202					X
TVR7202Q					X
TVR7105				X	*
TVR7105Q				X	*

The X symbol indicates the designated equilibrator for the sensor. The * symbol indicates that the sensor will also work with the marked equilibrator.

WHY EQUILIBRATION?

Over time and through repeated loading, individual pressure sensing elements will start to vary in sensitivity. The equilibrator applies a uniform pressure across the face of the sensor, allowing the software to easily see and quantify these variations.

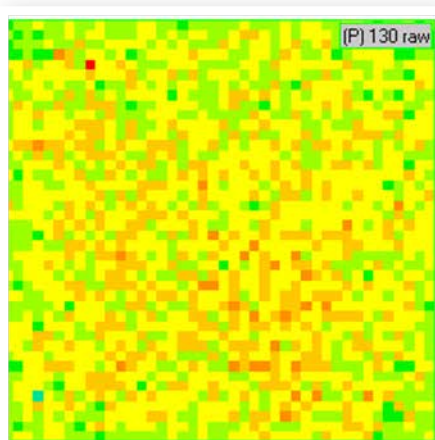

Sensor in Equilibrator before software equilibration is performed

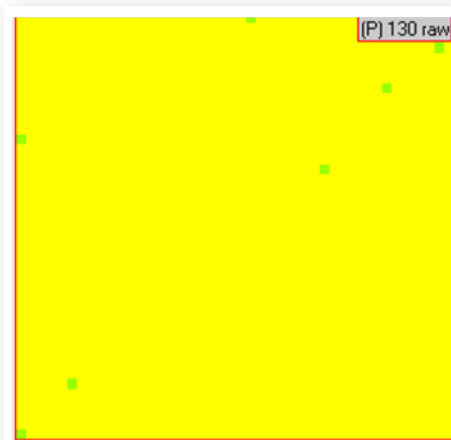

Sensor in Equilibrator after software equilibration is performed

RELATED PRODUCTS & OPTIONS

Tire Bead

In addition to measuring tire footprint pressure patterns, TireScan also allows the option of measuring tire bead pressure profiles. Please refer to the Sensor Catalog to view tire bead sensors.

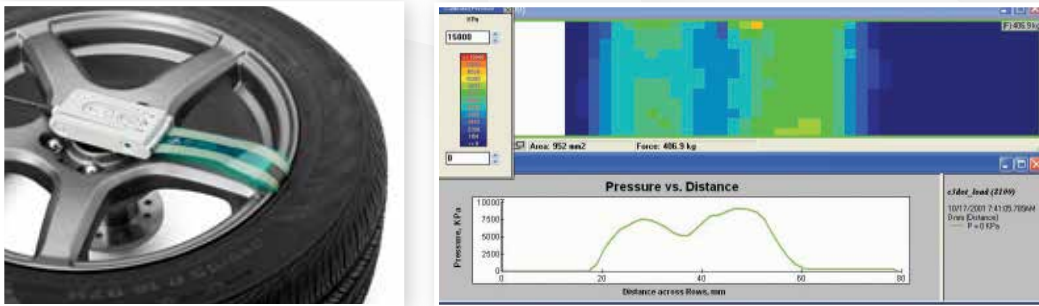

Above: 2D output and plot of the tire bead contact pressure profile.

The pressure profile is plotted from outside the tire, past the flange and bead, to inside the tire. The tire bead sensor shows the pressure on the bead at different points in the rotation, allowing for verification of good seal design on both sides of the tire. Tire bead sensor is compatible with slip ring for use while tire is spinning.

Analog Input

External data can be recorded and analyzed by TireScan software via USB-6008, an analog to digital input module (priced separately). Data from an analog sensor can now be evaluated against tactile sensor data in TireScan.

- Load cell connected to analog input channels can be used for real-time calibration of TireScan sensor
- Plot external sensor data against sensor pressure, area, and force data
- Export and import external analog data into TireScan

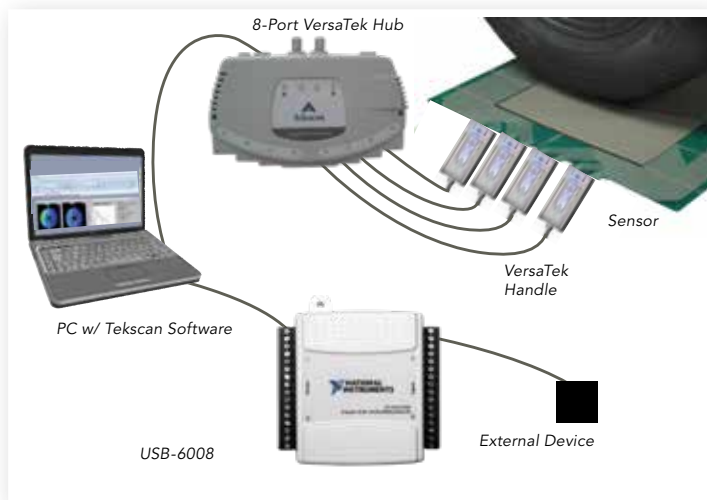

Optional USB-6008 Analog/Digital to USB converter

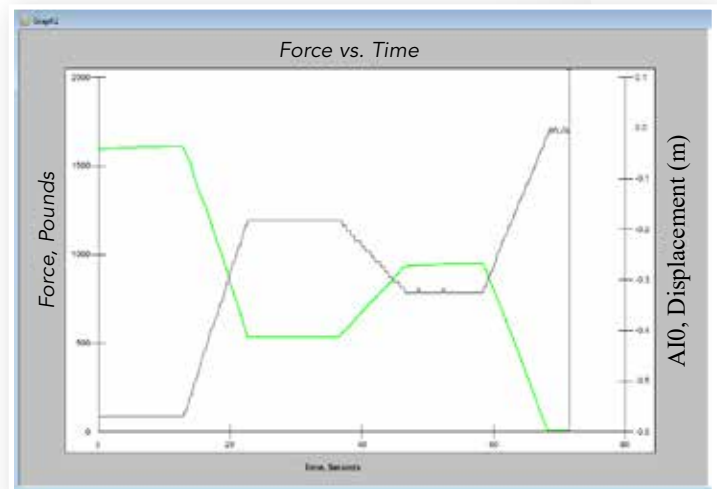

Analog input and Tekscan data

 **CONTACT US** | **FREE DEMONSTRATION**

+1.617.464.4282

| 1.800.248.3669

| info@tekscan.com

| www.tekscan.com/pm